

REGISTRO DE CONTROL DE LA
GRÚA MÓVIL LOCATELLI GRIL ATC20

A9
Pág. 1

VISTA LATERAL Y FRONTAL

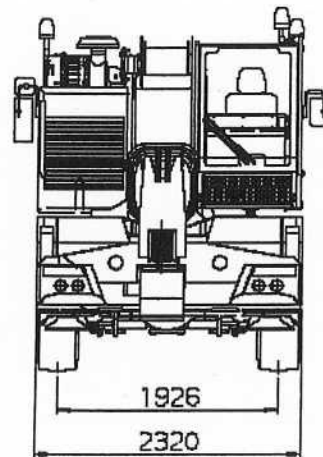
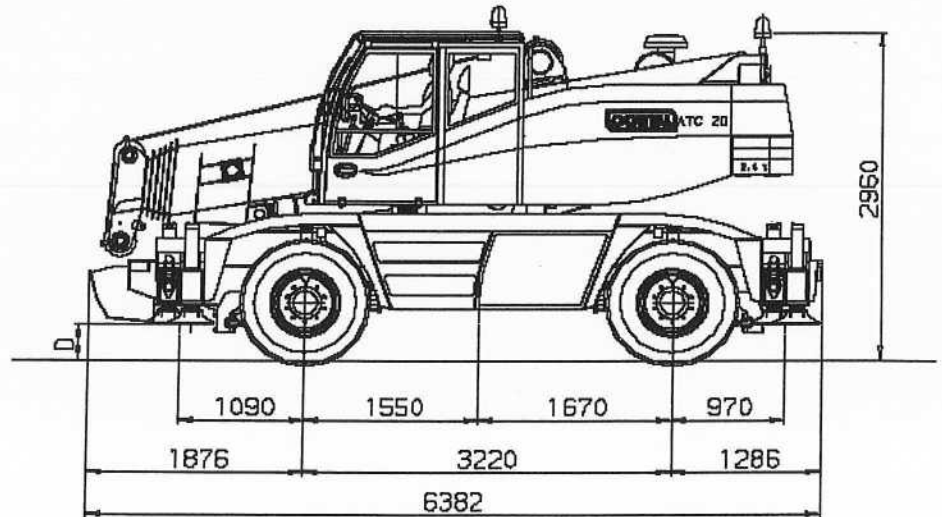

REGISTRO DE CONTROL DE LA
GRÚA MÓVIL LOCATELLI GRIL ATC20

A9
Pág. 2

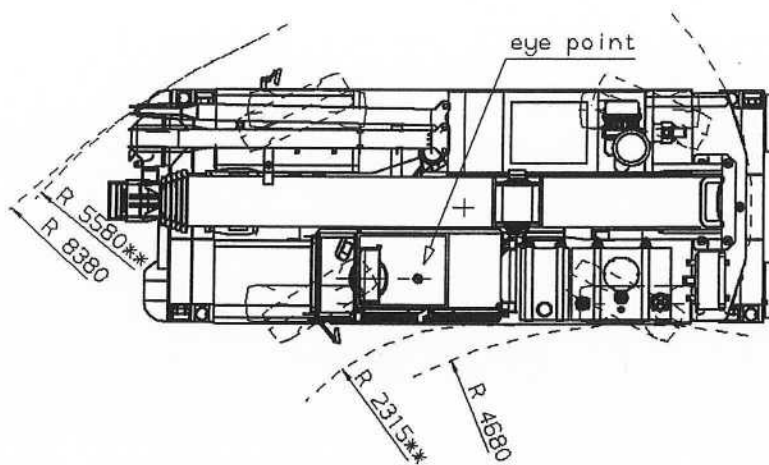
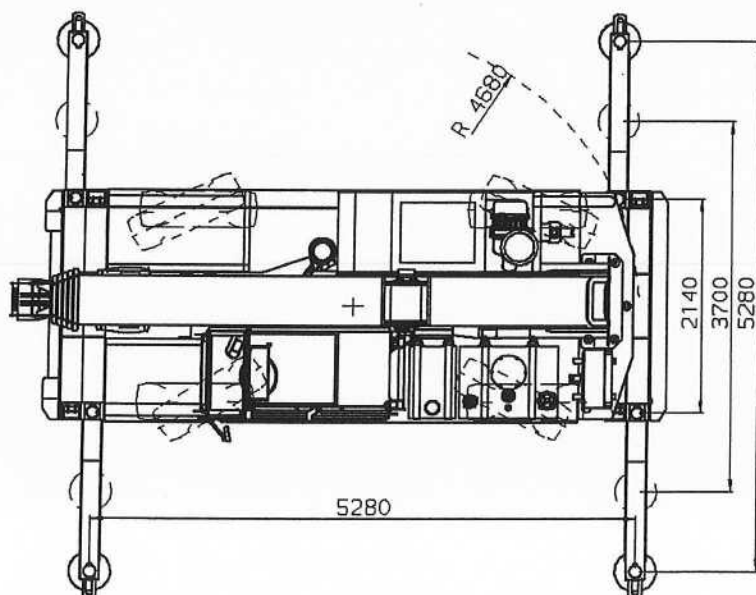

VISTA EN PLANO DE LA BASE ESTABILIZADA Y RADIO DE DIRECCIÓN





LOCATELLI

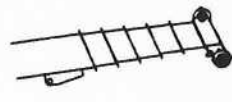

ATC 20

CE

				
5.28 m x 5.28 m	5.60 m + 23.80 m	2400 Kg.	360°	

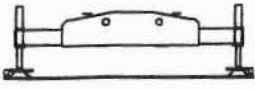
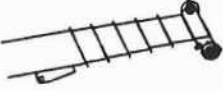
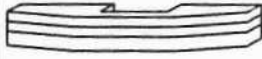

	 PROGRAM: 1					
	5.60 m	9.24 m	12.88 m	16.52 m	20.16 m	23.80 m
	TELE %	TELE %	TELE %	TELE %	TELE %	TELE %
	0-0-0-0-0	1-0-0-0-0	1-1-0-0-0	1-1-1-0-0	1-1-1-0.5-0.5	1-1-1-1-1
2.00	14500	-	-	-	-	-
2.50	12000	20000	14500	11200	9500	-
3.00	10800	18500	14500	11200	9500	6500
3.50	-	16500	13600	11000	9000	6500
4.00	-	14000	12700	10300	8600	6500
4.50	-	12200	11600	9700	8200	6200
5.00	-	10600	10600	9100	7700	6000
6.00	-	8400	8300	8000	6900	5600
7.00	-	-	6800	7000	6200	5200
8.00	-	-	5600	5800	5600	4700
9.00	-	-	4400	4700	5000	4400
10.00	-	-	-	3800	4200	4000
11.00	-	-	-	3100	3500	3700
12.00	-	-	-	2600	2900	3200
13.00	-	-	-	2100	2500	2700
14.00	-	-	-	-	2100	2300
15.00	-	-	-	-	1800	2000
16.00	-	-	-	-	1500	1700
17.00	-	-	-	-	1300	1500
18.00	-	-	-	-	-	1300
19.00	-	-	-	-	-	1100
20.00	-	-	-	-	-	1000
21.00	-	-	-	-	-	800

LOCATELL**ATC 20****CE**

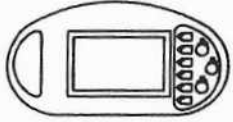
				
5.28 m x 3.70 m	5.60 m + 23.80 m	2400 Kg.	360°	

						
	PROGRAM: 3					
	5.60 m	9.24 m	12.88 m	16.52 m	20.16 m	23.80 m
TELE %	TELE %	TELE %	TELE %	TELE %	TELE %	
0-0-0-0-0	1-0-0-0-0	1-1-0-0-0	1-1-1-0-0	1-1-1-0.5-0.5	1-1-1-1-1	
2.00	14500	-	-	-	-	
2.50	12000	18300	14500	11200	9500	
3.00	10800	16200	14500	11200	9500	
3.50	-	14400	13600	11000	9000	
4.00	-	12400	12200	10300	8600	
4.50	-	10100	10100	9700	8200	
5.00	-	8100	8200	8600	7700	
6.00	-	5600	5700	6100	6500	
7.00	-	-	4200	4500	4900	
8.00	-	-	3100	3400	3800	
9.00	-	-	2400	2700	3000	
10.00	-	-	-	2100	2500	
11.00	-	-	-	1700	2000	
12.00	-	-	-	1300	1600	
13.00	-	-	-	1000	1300	
14.00	-	-	-	-	1100	
15.00	-	-	-	-	800	
16.00	-	-	-	-	700	
17.00	-	-	-	-	500	
18.00	-	-	-	-	-	
19.00	-	-	-	-	-	
20.00	-	-	-	-	-	
21.00	-	-	-	-	-	

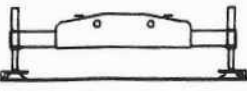
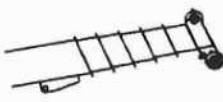
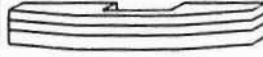
LOCATELLI**ATC 20****CE**

				
5.28 m x 2.14 m	5.60 m + 23.80 m	2400 Kg.	360°	

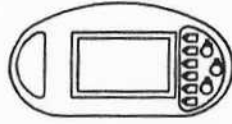
							PROGRAM: 5					
	5.60 m	9.24 m	12.88 m	16.52 m	20.16 m	23.80 m	TELE %	TELE %	TELE %	TELE %	TELE %	TELE %
	0-0-0-0-0	1-0-0-0-0	1-1-0-0-0	1-1-1-0-0	1-1-1-0.5-0.5	1-1-1-1-1						
2.00	14500	-	-	-	-	-						
2.50	12000	14000	13700	11200	9500	-						
3.00	10400	9900	10000	10300	9500	6500						
3.50	-	7400	7500	7800	8300	6500						
4.00	-	5800	5800	6200	6600	6500						
4.50	-	4600	4700	5000	5400	5700						
5.00	-	3800	3800	4100	4500	4800						
6.00	-	2600	2600	2900	3200	3500						
7.00	-	-	1800	2100	2400	2600						
8.00	-	-	1200	1500	1800	2000						
9.00	-	-	800	1000	1400	1600						
10.00	-	-	-	700	1000	1200						
11.00	-	-	-	400	700	900						
12.00	-	-	-	-	500	700						
13.00	-	-	-	-	-	500						
14.00	-	-	-	-	-	400						
15.00	-	-	-	-	-	-						
16.00	-	-	-	-	-	-						
17.00	-	-	-	-	-	-						
18.00	-	-	-	-	-	-						
19.00	-	-	-	-	-	-						
20.00	-	-	-	-	-	-						
21.00	-	-	-	-	-	-						

LOCATELLI

ATC 20

CE

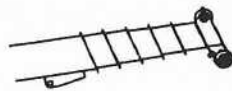
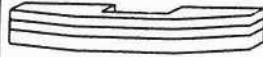
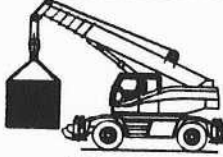
			
10 bar			
365/85 R20 XZL	5.60 m + 16.52 m	2400 Kg.	3 Km/h

				
	PROGRAM: 7			
	5.60 m	9.24 m	12.88 m	16.52 m
TELE %	TELE %	TELE %	TELE %	
0-0-0-0-0	0-1-0-0-0	0-1-1-0-0	0-1-1-0.5-0.5	
2.00	9100	-	-	
2.50	7700	7200	7000	
3.00	6700	6200	6100	
3.50	-	5400	5400	
4.00	-	4700	4700	
4.50	-	4100	4200	
5.00	-	3700	3700	
6.00	-	3000	3000	
7.00	-	-	2500	
8.00	-	-	1900	
9.00	-	-	1500	
10.00	-	-	1200	
11.00	-	-	-	
12.00	-	-	-	
13.00	-	-	-	
14.00	-	-	-	
15.00	-	-	-	
16.00	-	-	-	
17.00	-	-	-	

DIAGRAMMA DI LAVORO CON FALCONE SU 360°
FLY JIB WORKING AREA - 360°
HILFSAUSLEGER ARBEITSBEREICH - 360°
DIAGRAMME DE TRAVAIL AVEC EXTENSION - 360°
DIAGRAMA DE ALCANCES CON PLUMIN EN 360°

